

Sondar Ultrasonic Level Meter SLM300C/800C/990C

SONDAR



The SLM300C / 800C / 990C is a highly developed ultrasonic level measurement system, which provides in non-contacting level measurement for a wide variety of applications in liquid and solid.

This unit is designed for mounting above material level being measured. It offers the integral nose thread allowing a screw-fit or flange-fit to tanks or mounting-brackets. 4LED display enables highly accurate measurement monitoring.

Features

- High accuracy and resolution
- Two wire loop-powered
- Aluminum die-casting body
- Explosion-proof structure
- Integral 4 digits LCD display
- Display in distance, level, or space is selectable at user's need
- Sensor can be separated with extension pipe

Technical Specifications

Physical

Dimension

Overall 120(D)x260(H) mm
Transducer 67(D)x136(H) mm

Mounting

2 1/2" NPT

Weight

Nominal 3.2Kg

Case Material

Aluminum

Environmental

IP Rating

IP67

Temperature

-20°C~70°C

Pressure

Up to 2 Bar

Certification

CE

Ex dm II B T6

Choice of Unit

SLM300C 3m

SLM800C 8m

SLM990C 10m

Performance

Accuracy

0.25% of measured range

Resolution

1mm

Measuring range

0.30m~3m/8m/10m

Beam Angle

5° at -3dB

Damping Rate

Adjustable 0.1m/min to 100m/min

Temperature Compensation

fully compensated

Outputs

Analog Output

4~20mA into max 750 Ω

Display

4Digit LDC display

Supply

Power Supply

DC20 ~ 30V, Loop Powered

Current Consumption

Less than 0.021A

Option

Extension Pipe

300mm~ 1500mm



Sondar Ultrasonic Level Meter SLM 300C/800C/990C

SONDAR

Dimensions

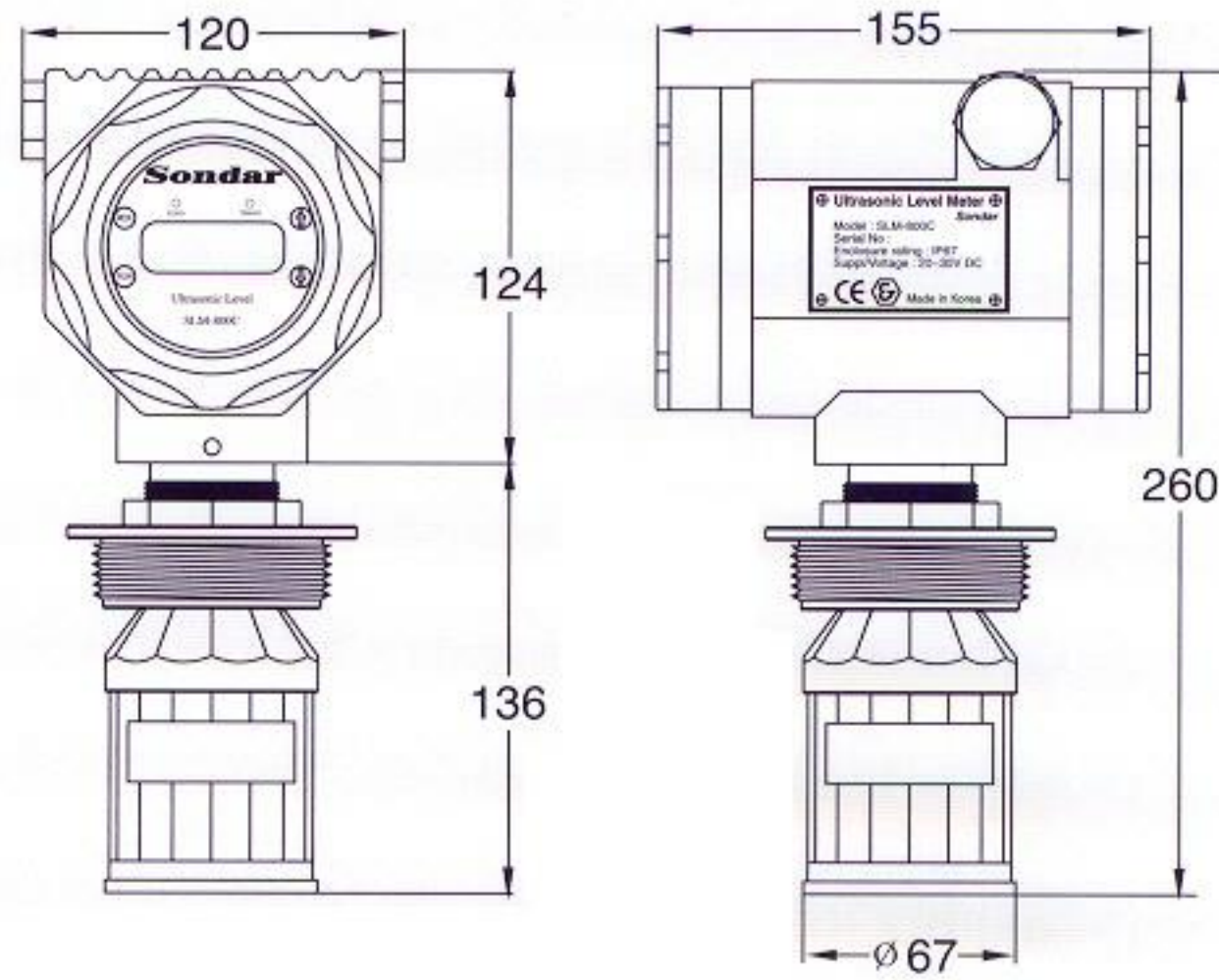

Technical Connection

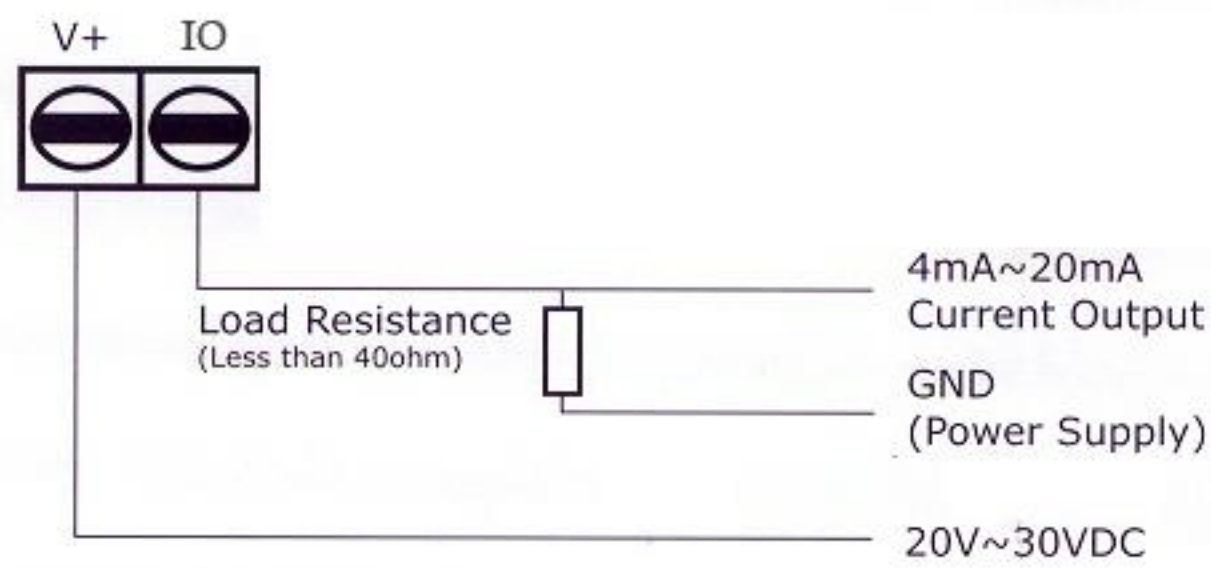

Ordering Code

